

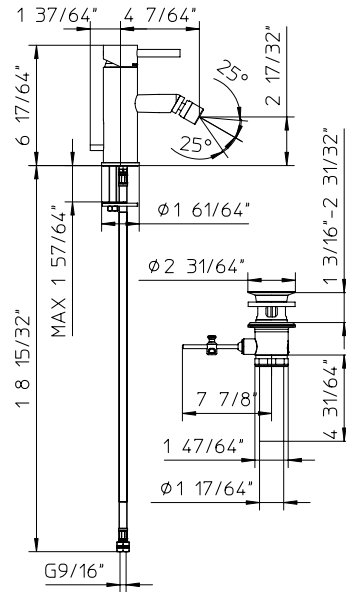

# PALAZZANI **idrotech**



code **124010-10**

## Features

- Single lever handle volume and temperature control.
- Temperature memory allows faucet to be turned on and off at any temperature setting.
- Included pop-up drain with 1-1/4" tailpiece.
- Ceramic disc valves longevity standards for a lifetime of durable performance.
- Valve body brass.

## Material

- Solid brass.
- Finishes resist corrosion and tarnish.

## Certifications

- ASME A112.18.1/CSA B125.1-12
- California Energy Commission (CEC).
- ADA.

## Available color finishes

- 10 chrome.

## Technical information

- All product dimensions are nominal.
- Handle clearance 2 3/4" (70mm).
- Faucet flow rate: 1.2 gpm.
- Pressure 60 psi.

## Warranty

- Limited warranty.
- See website for detailed warranty information.

## Note

- Install this product according to the installation guide.
- Final measurements confirm with product.
- Palazzani reserves the right to make revisions without notice to product specifications.



**PALAZZANI USA**

phone (305) 651.4470 ■ service@palazzaniusa.com