

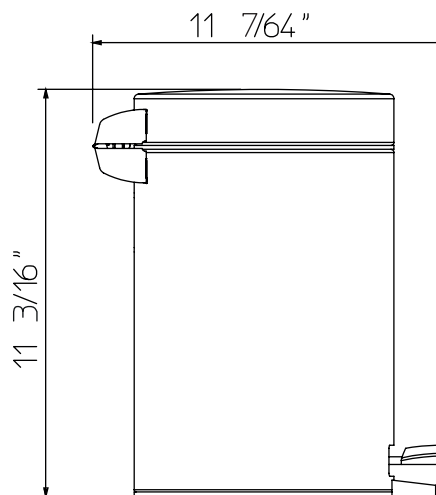

PALAZZANI

accessories



code **9943E4-10**

Features

- 5 liters dustbin with lid and basket.

Material

- Inox
- Finishes resist corrosion and tarnish.

Certifications

- ADA.

Available color finishes

- 10 black.

Technical information

- All product dimensions are nominal.

Warranty

- Limited warranty.
- See website for detailed warranty information.

Note

- Install this product according to the installation guide.
- Final measurements confirm with product.
- Palazzani reserves the right to make revisions without notice to product specifications.



PALAZZANI USA

phone (305) 651.4470 ■ service@palazzaniusa.com