

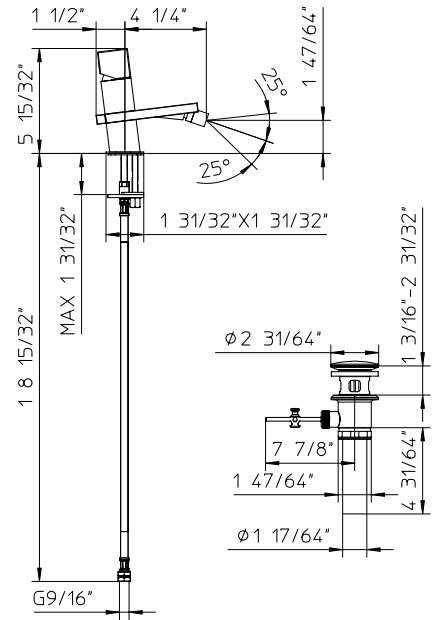

PALAZZANI

track



code **094010-10**

Features

- Single lever handle volume and temperature control.
- Temperature memory allows faucet to be turned on and off at any temperature setting.
- Included pop-up drain with 1-1/4" tailpiece.
- Ceramic disc valves longevity standards for a lifetime of durable performance.
- Valve body brass

Material

- Solid brass.
- Finishes resist corrosion and tarnish.

Certifications

- ASME A112.18.1/CSA B125.1-12
- California Energy Commission (CEC)
- ADA

Available color finishes

- 10 chrome

Technical information

- All product dimensions are nominal
- Handle clearance 1-31/32" (50mm)
- Faucet flow rate: 1.2 gpm
- Pressure 60 psi

Warranty

- Limited warranty.
- See website for detailed warranty information.

Note

- Install this product according to the installation guide.
- Final measurements confirm with product
- Palazzani reserves the right to make revisions without notice to product specifications.



PALAZZANI USA

phone (305) 651.4470 ■ service@palazzaniusa.com